



Installation instructions, accessories

Volvo Car Corporation Gothenburg, Sweden

Instruction No	Version	Part. No.
31428111	1.3	31442556, 31442553

Mirror, rearview, autodimming

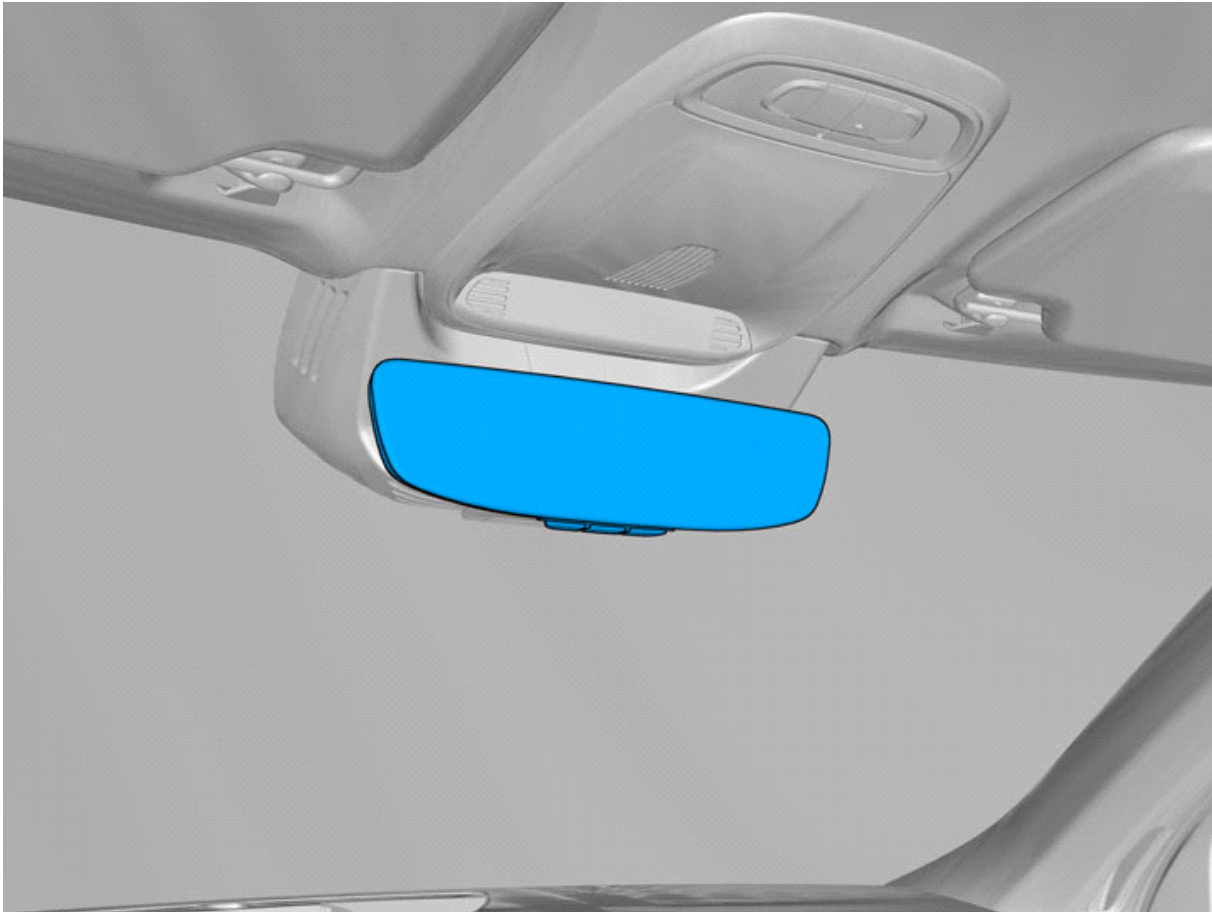

IMG-382373



Installation instructions, accessories

Volvo Car Corporation Gothenburg, Sweden

Equipment

VIDA

IMG-242205

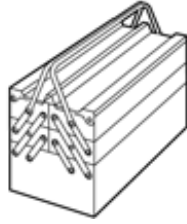

IMG-345497

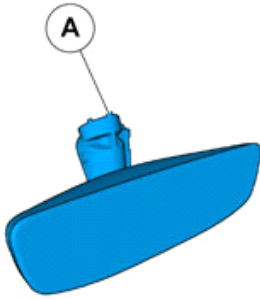

IMG-382376



Installation instructions, accessories

Volvo Car Corporation Gothenburg, Sweden

Information

1

Read through all of the instructions before starting installation.

Notifications and warning texts are for your safety and to minimise the risk of something breaking during installation.

Ensure that all tools stated in the instructions are available before starting installation.

Certain steps in the instructions are only presented in the form of images. Explanatory text is also given for more complicated steps.

In the event of any problems with the instructions or the accessory, contact your local Volvo dealer.

Color symbols

2

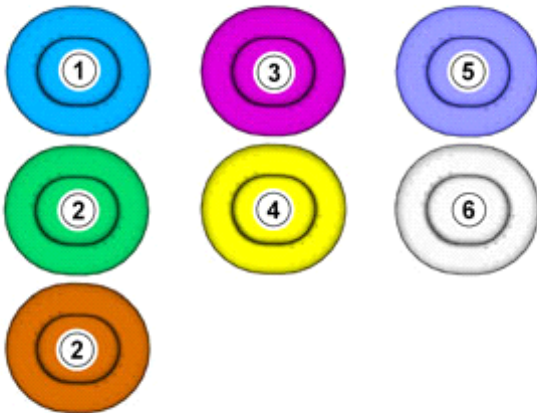

IMG-363036

Note!

This colour chart displays (in colour print and electronic version) the importance of the different colours used in the images of the method steps.

- Used for focused component, the component with which you will do something.
- Used as extra colors when you need to show or differentiate additional parts.
- Used for attachments that are to be removed/installed. May be screws, clips, connectors, etc.
- Used when the component is not fully removed from the vehicle but only hung to the side.
- Used for standard tools and special tools.
- Used as background color for vehicle components.

Removal

3

Turn off the ignition.



Installation instructions, accessories

Volvo Car Corporation Gothenburg, Sweden

4

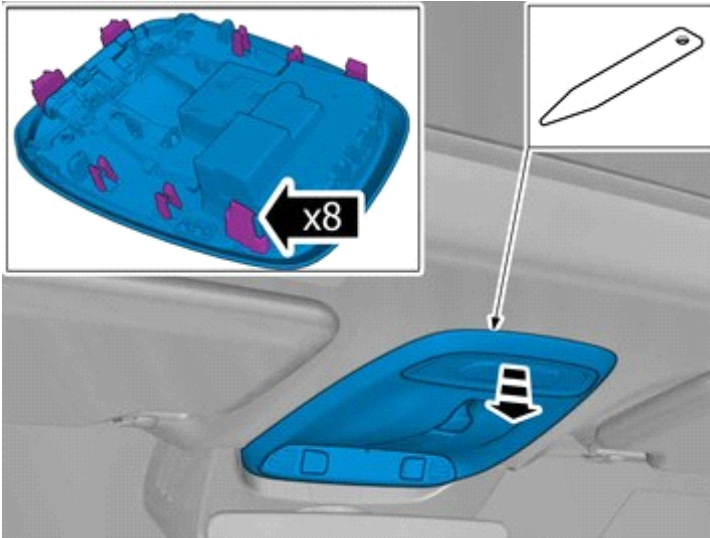

IMG-397174

Remove the panel.

5

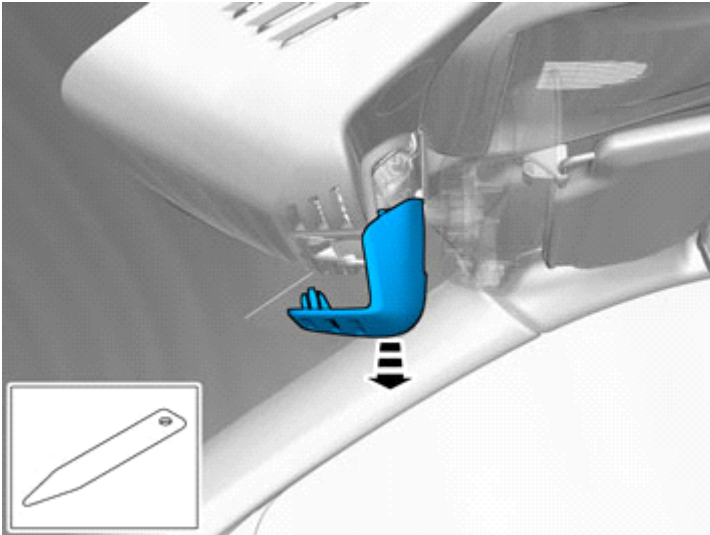

IMG-382384

Remove the panel.

6

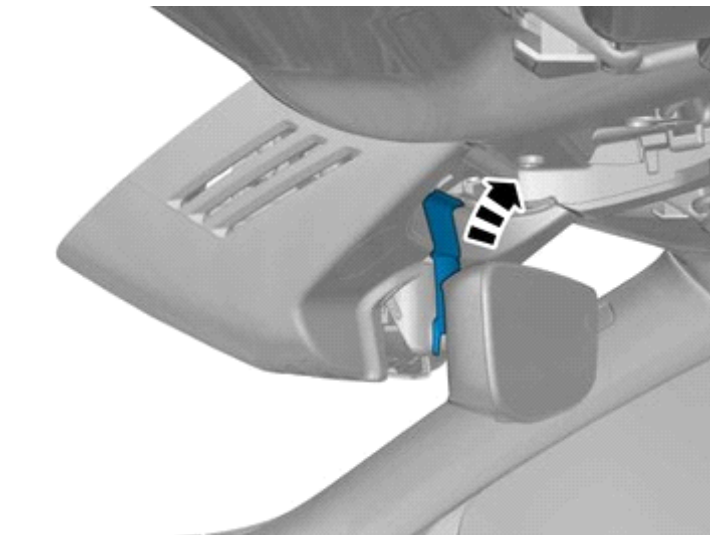

IMG-397175

Remove the panel.



Installation instructions, accessories

Volvo Car Corporation Gothenburg, Sweden

7

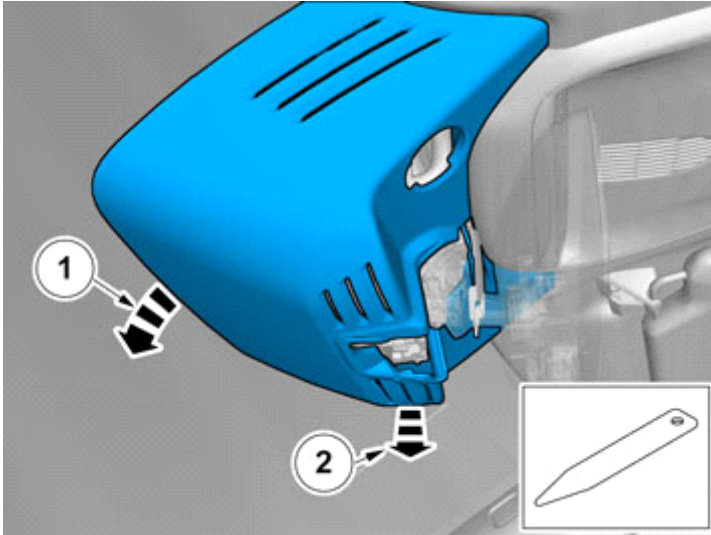

IMG-382385

Remove the panel.

8

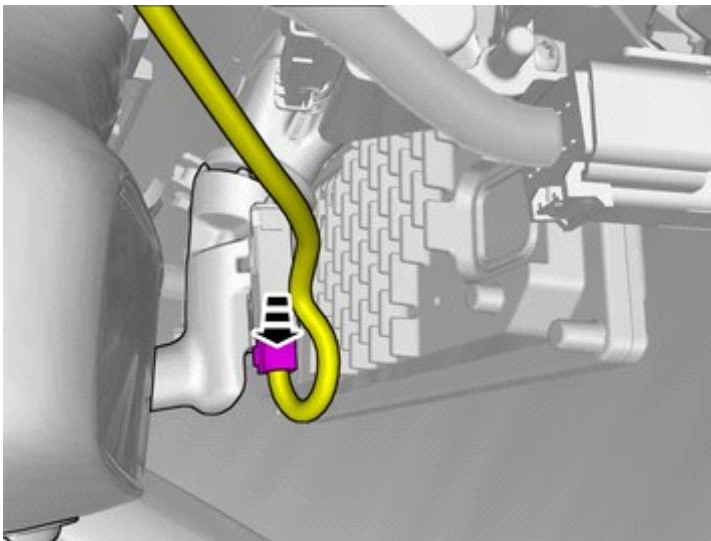

IMG-396420

Disconnect the connector.

9

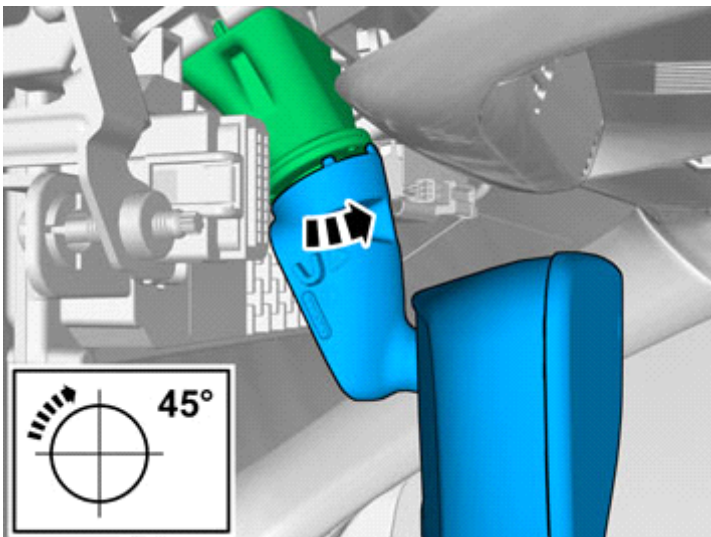

IMG-382394



Installation instructions, accessories

Volvo Car Corporation Gothenburg, Sweden

Accessory installation

10

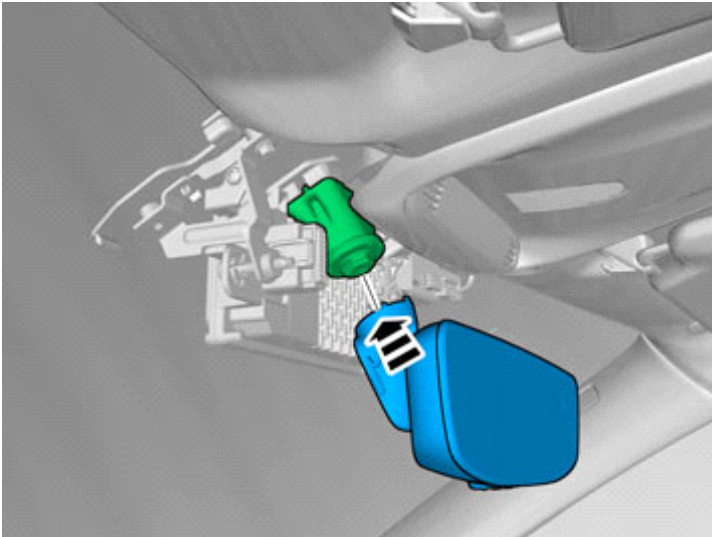

IMG-382396

Install component that comes with the accessory kit.

11

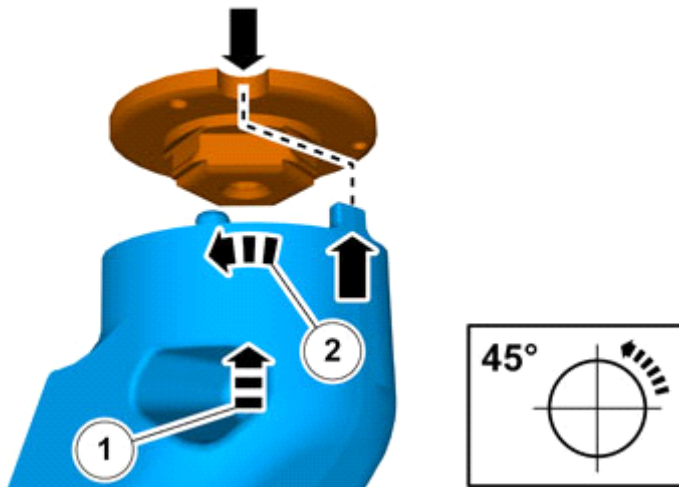

IMG-338619



Installation instructions, accessories

Volvo Car Corporation Gothenburg, Sweden

12

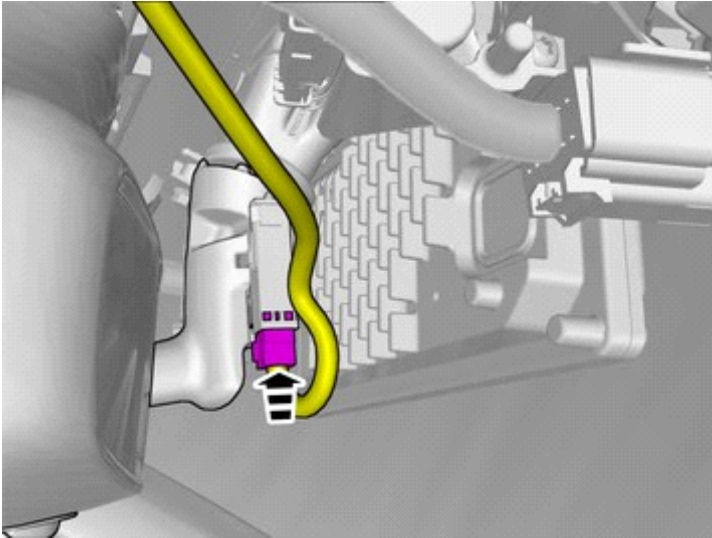

IMG-396421

Connect the connector.

13

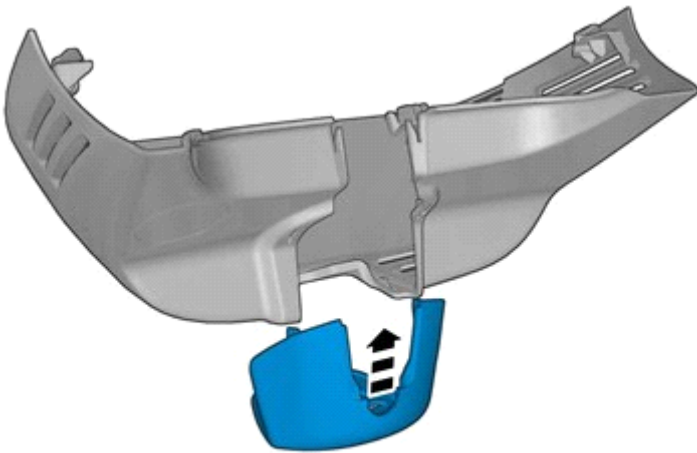

IMG-397176

Install the panel.

14

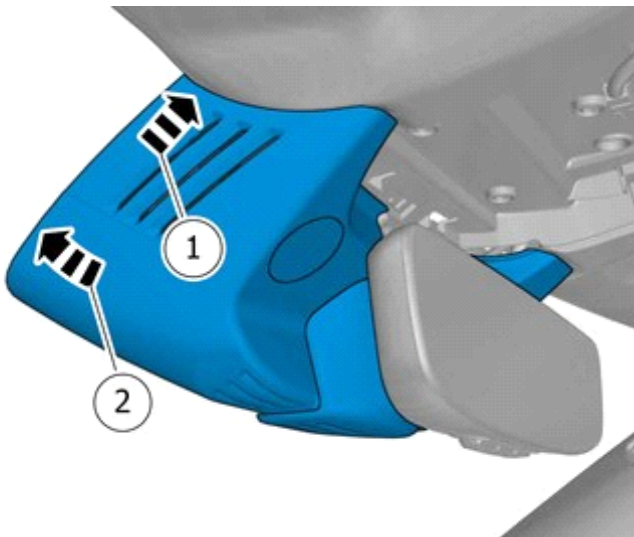

IMG-397178

Install the panel.



Installation instructions, accessories

Volvo Car Corporation Gothenburg, Sweden

15

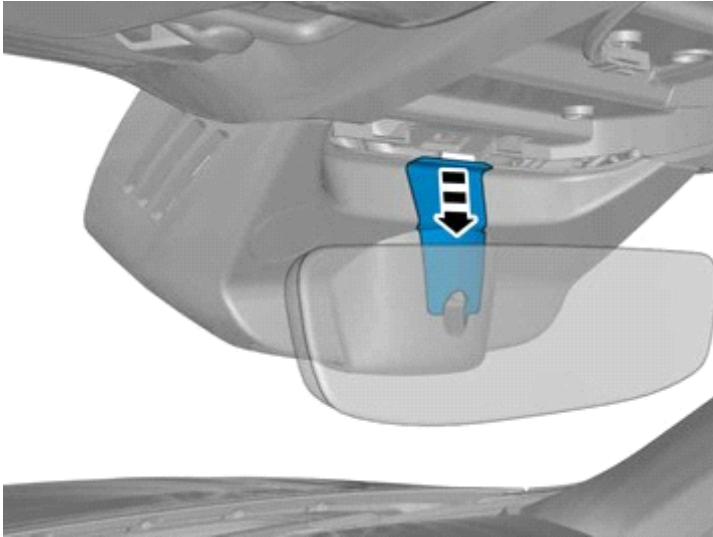

IMG-397177

Install the panel.

16

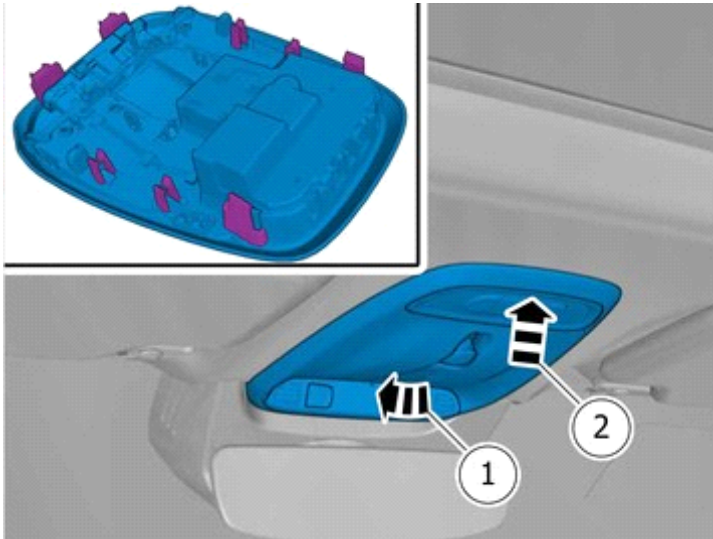

IMG-397179

Install the panel.

17

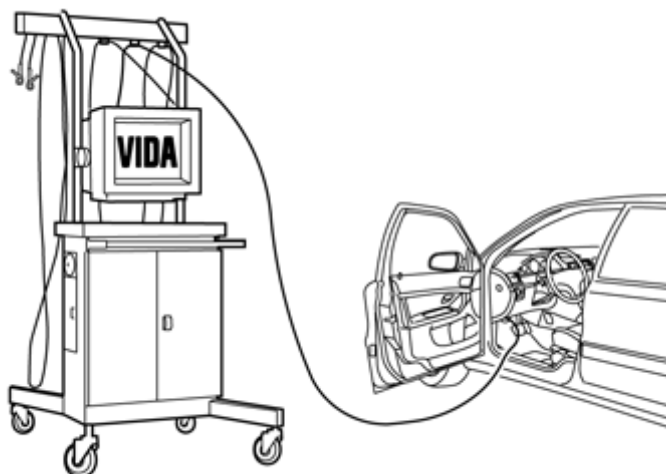

IMG-242268

Download software (application) for the accessory's function according to the service information in VIDA. See VIDA or the accessories catalogue for software part number.



Installation instructions, accessories

Volvo Car Corporation Gothenburg, Sweden

Calibration

18

Compass

Refer to Owner's manual
